



The Company With Connections®



**PIPE TO STRUCTURE CONNECTOR FOR STORMWATER SYSTEMS**

# A•LOK STM

## ● A•LOK STM

The **A•LOK STM** is a flexible pipe-to-man-hole connector designed for the prevention of soil and water infiltration into stormwater sewer systems. It can be used with both round and elliptical shaped pipes and curved and flat wall structures. It is available for 8" diameter and larger pipes.



## ● MATERIAL

The standard connector is extruded from a polyisoprene compound engineered to conform with the requirements outlined in section 4.1.1 of ASTM C-1478 "Standard Specification for Storm Drain Resilient Connectors Between Reinforced Concrete Storm Sewer Structures, Pipes, and Laterals". Alternative compounds are available for unusual applications upon special order.

## ● KEY ADVANTAGES

The **A•LOK STM Connector** functions on pure compression, making field installation quick and easy. Just clean and lubricate the connector and pipe, center the pipe in the connector, and insert. This rapid installation permits immediate backfilling, enhancing project safety and overcomes the normal problems encountered with water, running sand and other unstable trench conditions. This results in shorter job projections, while minimizing traffic interruption and cost overruns.

The **A•LOK STM** provides up to 10° of omnidirectional deflection while still maintaining a watertight seal. This design allows the connector to compensate for shear due to settlement or ground movement preventing water and soil infiltration into the sewer system. This proper pipe-to-structure connection minimizes the chance of pothole formation and sediment build-up in the storm system, saving states and municipalities money over the life of the structure.

On larger diameter pipe when size prohibits a gasket from being installed in a flat plane, an **A•LOK STM Connector** can be configured for casting in a curve with the connector staying perpendicular to the center line of the pipe. This design has resulted from years of extensive research and development and causes no loss of compression or deflection.

## ● PRODUCT REFERENCES

### A.) ASTM C-1478

Standard Specification for Storm Drain Resilient Connectors Between Reinforced Concrete Storm Sewer Structures, Pipes, and Laterals.

### B.) ASTM C-1244

Standard Test Method For Concrete Sewer Manholes by the Negative Air Pressure (Vacuum) Test

### C.) ASTM C-478

Standard Specification for Precast Reinforced Concrete Manhole Sections

## ● PERFORMANCE STANDARD

The **A•LOK STM** meets or exceeds all material and test requirements of ASTM C-1478: "Standard Specification for Storm Drain Resilient Connectors Between Reinforced Concrete Storm Sewer Structures, Pipes, and Laterals".

See following chart:

### RESILIENT MATERIAL TEST OF ASTM C-1478

TEST	RESULTS	ASTM METHOD
Chemical resistance 1 N Sulfuric acid 1 N Hydrochloric Acid	no weight loss no weight loss	D 543 at 22°C for 48h
Tensile strength	1200 psi or 8.5 MPa, min	D 412
Elongation at break	350% min.	
Hardness	±5 from mfg's. specified hardness	D 2240 (Shore A durometer)
Accelerated oven-aging	decr. of 15%, max. of original tensile strength, decr. of 20% max. of elongation	D 573, 70±1°C for 7 days
Compression set	decr. of 25%, max. of original deflection	D 395, Method B, at 70°C for 22h
Water absorption	increase of 10%, max. of original by weight	D 471, immerse 0.75 by 2-in. or 19 by 25-mm Specimen in distilled water at 70°C for 48h
Ozone resistance	rating 0	D 1171
Low-temp brittle point	no fracture at -40°C	D 746
Tear resistance	200 lbf/in. or 34 kn/m	D 624, Method B

Copyright ASTM INTERNATIONAL. Reprinted with permission

# PART 6 • DIMENSIONAL DATA

## A•LOK STM Cross Section / Pipe Size OD's



93 Series  
8.50" - 29.00"



94 Series  
30.00" - 59.50"



95 Series  
60.00" - 87.50"

Larger Sizes Available  
Upon Special Request

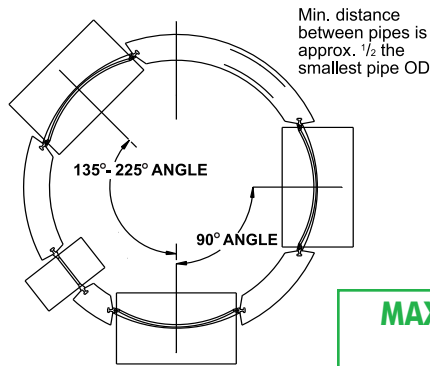

MAX. PIPE SIZE OD's

### MAX. PIPE SIZE OD's

Manhole Diameter	135° - 225° Pipe Angle	90° Pipe Angle
42"	26.5"	22.0"
48"	31.5"	25.0"
60"	42.0"	32.0"
72"	52.5"	38.0"
84"	59.5"	44.0"
96"	73.5"	50.0"
108"	76.0"	56.0"
120"	85.0"	62.0"

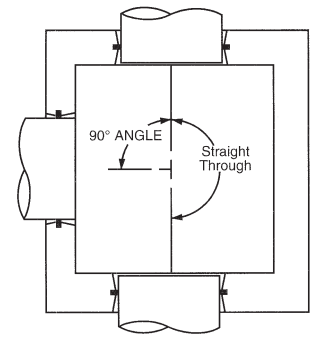

### MAX. PIPE SIZE OD's BOX STRUCTURES

Inside Wall Dimension	Straight Through	90° Pipe Angle
2'	19.50"	17.50"
3'	32.00"	30.00"
4'	44.00"	42.00"
5'	56.00"	54.00"
6'	67.00"	65.00"
7'	80.50"	78.50"
8'	91.25"	89.25"
9'	103.25"	101.25"

## INSTALLATION INSTRUCTIONS

### STEP 1:

Confirm that the pipe surface is smooth, clean and free of foreign materials, chips, gouges and form seams due to manufacturing or handling. Slightly bevel any sharp or blunt edges caused by the cutting of the pipe.

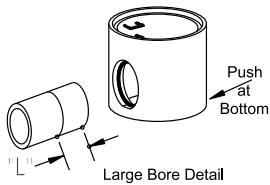

### STEP 2:

Lubricate the connector and the entire section of the pipe that will be inserted into the connector. The chart below lists A-LOK's minimum lubrication length "L".

PIPE SIZE	MIN. LUBRICATION LENGTH "L"
4" - 15"	12"
16" - 18"	18"
21" & Larger	24"

### STEP 3:

Center the pipe and connector square to each other and insert the pipe into the connector using a bar or back hoe depending on the size. Once the pipe is coupled with the connector, deflect the structure or pipe to achieve the proper angle.

### WARNING

To ensure the A-LOK STM Connector remains a flexible watertight connector, it is **A-LOK Products, Inc.** strong recommendation that no mortar be placed between the pipe and wall of the concrete structure. The use of mortar in this area would decrease the effectiveness of the connector to compensate for shear caused by settlement or ground movement.

### NOTE:

To find approximate subgrade, measure from the outside base of the structure to the junction of the connector and flat spot. Then add the wall thickness of the pipe plus 1/4 inch.

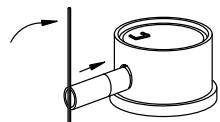
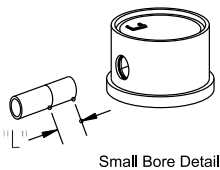
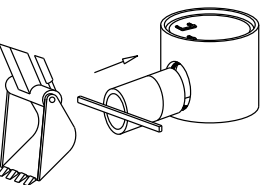

### CAUTION:

When installing pipe stubs for future pipeline installation, all stubs must be properly restrained to prevent any movement by means other than the **A-LOK STM Connector**.

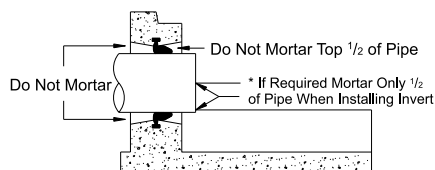

## PRODUCT SPECIFICATIONS

A flexible pipe to manhole connector shall be used whenever a pipe penetrates into a precast concrete manhole or structure used in a stormwater drainage system.

The connector shall be the **A•LOK® STM CONNECTOR** as manufactured by **A•LOK PRODUCTS, INC.**, Tullytown, PA, or approved equal.

The design of the connector shall provide a flexible, watertight seal between the pipe and concrete structure. The connector shall assure that a seal is made between:

(1) The connector and the structure wall by casting the connector integrally with the structure wall during the manufacturing process in a manner that it will not pull out during pipe coupling. The connector shall also be capable of being cast into a round structure by curving the connector in a manner that allows it to remain centrally located within the structure wall and perpendicular to the pipe. This configuration will result in no loss of seal or deflection of pipe entering a concrete structure.

(2) The seal between the connector and the pipe shall be made by the compression of the connector between the outside circumference of the pipe and the interior hole opening of the structure. The connector shall be the only component to affect the seal between the pipe and structure.

The connector shall be made from materials that conform to the physical and chemical requirements outlined in Section 4, "Materials and Manufacture" of ASTM C-1478 "Standard Specification for Storm Drain Resilient Connectors Between Reinforced Concrete Storm Sewer Structures, Pipes, and Laterals," and the overall design will meet or exceed Section 7, "Test Methods and Requirements" of ASTM C-1478.

The connector shall be sized specifically for the type of pipe being used and shall be installed in accordance with the recommendations of the manufacturer.

**ANY QUESTIONS REGARDING A•LOK STM CONNECTOR  
INSTALLATION, PLEASE CALL 1-800-822-2565**